

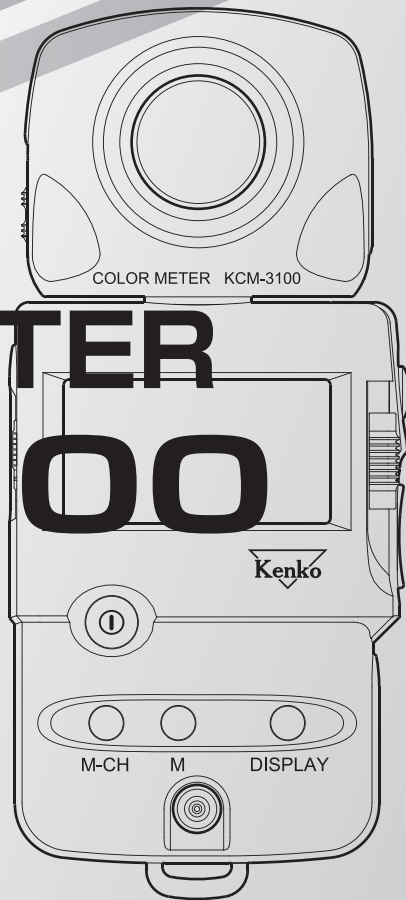

COLOR METER KCM-3100

INSTRUCTION MANUAL



KENKO COLOR METER KCM-3100

(English)

The Kenko Color Meter KCM-3100 helps to ensure consistent results when taking color photographs using either ambient or flash light. It measures the light illuminating the subject and determines the filtration required to reproduce subject colors correctly. Readings are provided for both light-balancing filters (as required mired shift or Kodak Wratten filter numbers) and color-compensating filters (as density). In addition, the photographic color temperature of the illumination can also be displayed. The meter can be set to determine the required filters for any of three film types: Daylight (balanced to 5500K), Type-A Tungsten (balanced to 3400K), or Type-B Tungsten (balanced to 3200K).

Either ambient or flash measurements can be taken. Ambient measurements can be taken under illumination levels from EV3 to EV16.3 at ISO100. Flash measurements can be taken for flash power levels corresponding to apertures (at the meter position) of from f/2.8 to f/180 (at ISO 100); they can be taken with or without a sync cord, and shutter speeds from 1/500 to 1 sec. can be selected. For flash measurements, the meter measures the mixed flash and ambient light, since this is what will actually illuminate the subject, at the selected shutter speed. After measurement, the shutter speed can be changed, effectively changing the ratio of flash to ambient light; by noting the change in required filtration, you can predict the effect on the image color. In addition, the Color Meter KCM-3100 can subtract out the ambient light to display the results for only the light from the flash.

To allow you to adjust the meter to your color preferences, correction values can be set in any of the meter's nine memory channels. Once these values have been set, the meter will automatically adjust measurement calculations to ensure that colors are reproduced according to your expectations.

Please take a moment to read this manual before using the Color Meter KCM-3100 for the first time, and keep it handy for future reference.

STATEMENT OF FCC COMPLIANCE

This device complies with Part 15 of the FCC Rules. Operation is subject to the following two conditions : (1) This device may not cause harmful interference, and (2) this device must accept any interference received, including interference that may cause undesired operation. Changes or modifications not approved by the party responsible for compliance could void the user's authority to operate the equipment. This equipment has been tested and found to comply with the limits for a Class B digital device, pursuant to Part 15 of the FCC Rules. These limits are designed to provide reasonable protection against harmful interference in a residential installation. This equipment generates, uses and can radiate radio frequency energy and, if not installed and used in accordance with the instructions, may cause harmful interference to radio communications. However, there is no guarantee that interference will not occur in a particular installation. If this equipment does cause harmful interference to radio or television reception, which can be determined by turning the equipment off and on, the user is encouraged to try to correct the interference by one or more of the following measures:

Reorient or relocate the receiving antenna.

Increase the separation between the equipment and receiver.

Connect the equipment into an outlet on a circuit different from that to which the receiver is connected.

Consult the dealer or an experienced radio/TV technician for help.

STATEMENT OF DOC COMPLIANCE





This digital apparatus does not exceed the Class B limits for radio noise emissions from digital apparatus as set out in the Radio Interference Regulations of the Canadian Department of Communications.

Table of Contents

NAMES OF PARTS	6	TAKING MEASUREMENTS	17
DATA PANEL	8	Ambient Light Measurements	17
Over-/Under-Range Indications.....	9	Flash Measurements.....	18
OVER/UNDER MEASURING RANGE.....	9	WITH AN OVER-THE-COUNTER SYNC CORD.....	18
OVER/UNDER DISPLAY RANGE.....	10	WITHOUT AN OVER-THE-COUNTER SYNC CORD.....	20
Photographic Color Temperature, LB Index, or CC Index.....	10	ANALYZE FUNCTION: MEASURING	
LB Filter Number.....	10	ONLY FLASH IN MIXED LIGHTING	21
PREPARATIONS	11	USING MEMORY CHANNELS TO ADJUST METER READINGS	22
Power.....	11	Selecting Memory Channel	22
INSTALLING BATTERIES	11	Setting Correction Values	23
SWITCHING POWER ON AND OFF.....	12	SELECTING FILTERS	24
AUTO POWER OFF.....	12	Selecting LB Filters	24
LOW-POWER WARNING	12	Display of LB filter numbers.....	24
Setting Film-Type Switch	13	Display of LB index.....	25
Selecting Display Mode	14	Selecting CC Filters.....	26
DISPLAY MODES	14	Exposure Correction When Using Filters.....	26
LB and CC Indexes	14	Exposure Increments Table.....	27
LB Filter Number and CC Index.....	14	CARE AND STORAGE	28
Photographic Color Temperature	14	BATTERY CAUTIONS	28
NOTES ON MEASUREMENTS	15	SPECIFICATIONS	29

Safety-related Icons

The following icons are used in this manual to alert you to important information for preventing accidents due to improper handling of equipment.

 WARNING	This indicates a danger that improper use of the instrument will lead to death or serious injury of the user.
 CAUTION	This indicates a danger that improper use of the instrument will lead to injury of the user or to property damages.
 PROHIBITION	This denotes actions to be strictly avoided. Make sure to avoid these actions.
 PROHIBITION	This denotes actions to be avoided. Do not attempt to disassemble the product.

Safety Warnings and Cautions

To ensure proper use of the instrument, take special care to observe the following handling instructions when using this instrument. Read this instruction manual carefully and keep it securely in a place where you can refer to it readily.

 **WARNING** indicates a danger that improper use of the instrument will lead to the death or serious injury of the user.

 Do not use the instrument in a place where inflammable or combustible vapors (e.g. gasoline) are present. Otherwise there is a risk of causing a fire.

 Do not throw batteries into fire. Do not recharge (nonrechargeable batteries), short circuit, heat or disassemble batteries. Otherwise, there is a risk of causing fire or injury due to an explosion or fluid leakage.

 Never attempt to disassemble or modify the instrument yourself. Otherwise there is a risk of causing fire or electric shock.

 Never attempt to look directly at the sun through the viewfinder of the meter. Doing so will damage your eyesight.

 The instrument should not be operated if it is damaged, or smoke or odd smells occur. Doing so may result in a fire. In such situations turn off the power immediately, disconnect the AC adapter, and contact the nearest authorized service facility.

 **CAUTION** indicates a danger that improper use of the instrument will lead to injury to the user or to property damage.

 Do not use any batteries other than those designated for use with the instrument. When fitting batteries into the meter, make sure to align them according to the polarity shown on the instrument (plus "+" and minus "-"). Otherwise there is a risk that the batteries may leak or become damaged, leading to fire, injury or pollution of the surrounding environment.

 Do not walk around while looking into the viewfinder. Doing so may result in a fall or other accident.

 Do not leave the instrument within reach of infants. Falling or collapsing of the instrument may cause injury, and twining of the strap around the neck may cause suffocation.

STATEMENT OF FCC COMPLIANCE

This equipment has been tested and found to comply with the limits for a Class B digital device, pursuant to Part 15 of the FCC Rules. These limits are designed to provide reasonable protection against harmful interference in a residential installation. This equipment generates, uses and can radiate radio frequency energy and, if not installed and used in accordance with the instructions, may cause harmful interference to radio communications. However, there is no guarantee that interference will not occur in a particular installation. If this equipment does cause harmful interference to radio or television reception, which can be determined by turning the equipment off and on, the user is encouraged to try to correct the interference by one or more of the following measures:

- Reorient or relocate the receiving antenna.
- Increase the separation between the equipment and receiver.
- Connect the equipment into an outlet on a circuit different from that to which the receiver is connected.
- Consult the dealer or an experienced radio/TV technician for help.

This Class B digital apparatus complies with Canadian ICES-003.

NAMES OF PARTS

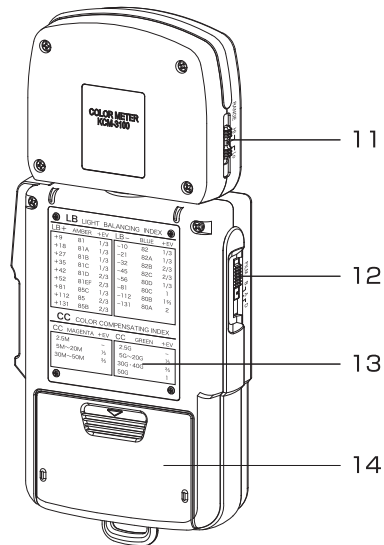
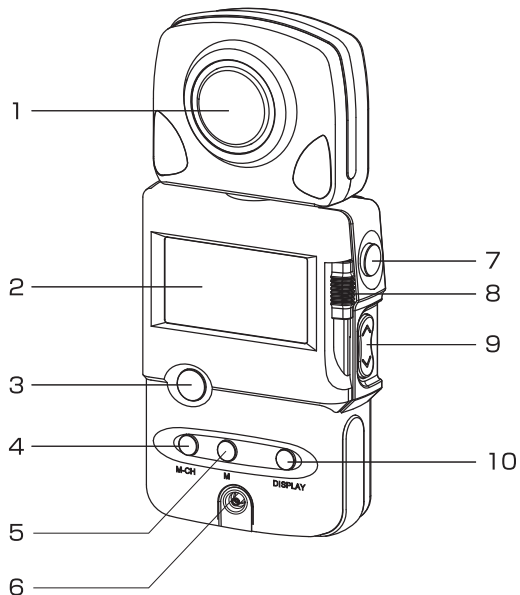

LB LIGHT BALANCING INDEX

LEF	INDEX	TEMP	BLUE	INDEX
0	81	1/3	20	100
+18	81A	1/3	-20	100
+27	81B	1/3	-30	100
+36	81C	1/3	-40	100
+45	81D	1/3	-45	100
+54	81E	1/3	-50	100
+63	81F	1/3	-55	100
+72	81G	1/3	-60	100
+81	81H	1/3	-65	100
+90	81I	1/3	-70	100
+99	81J	1/3	-75	100
+108	81K	1/3	-80	100
+117	81L	1/3	-85	100
+126	81M	1/3	-90	100
+135	81N	1/3	-95	100
+144	81O	1/3	-100	100

CC COLOR COMPENSATING INDEX

TEMP	INDEX	TEMP	INDEX
5000K	200	5000K	200
5500K	250	5500K	250
6000K	300	6000K	300
6500K	350	6500K	350
7000K	400	7000K	400
7500K	450	7500K	450
8000K	500	8000K	500

1.Receptor diffuser**2.Data panel****3.POWER button**

Switches power on and off.

4.Memory channel (M-CH) button

When held pressed, allows memory channel to be selected using up/down control.

5.Memory (M) button

When held pressed, allows data in memory to be changed using up/down control.

6.Sync terminal

For connecting flash sync cord.

7.Measuring button

Takes measurements.

8.Measuring-mode switch

Selects measuring mode:

"**AMBI**" : Ambient light measurements (see p.17)

"**CORD**" : Flash measurements with a sync cord (see p.18)

"**NON.C**" : Flash measurements without a sync cord (see p.20)

9.Up/down control

- Adjusts shutter speed in "**CORD**" or "**NON.C**" measuring modes.
- Adjusts memory channel when used with memory channel button.
- Adjusts data in memory when used with memory button.

10.DISPLAY button

Changes display mode in the following order :
 ...→ LB/CC indexes → LB filter number/CC index →
 Photographic color temperature → LB/CC indexes →...

11.Flash-range switch

Selects measuring range for flash measurements:

Lo : f/2.8 to 22 (approx.)

Hi : f/22(approx.) to 180

- The **Lo** and **Hi** ranges overlap by approximately 1EV.

12.Film-type switch

Selects film type:

B : Type-B tungsten film balanced for 3200K

A : Type-A tungsten film balanced for 3400K

D : Daylight film balanced for 5500K

13.Filter tables**14.Battery-chamber cover**

DATA PANEL

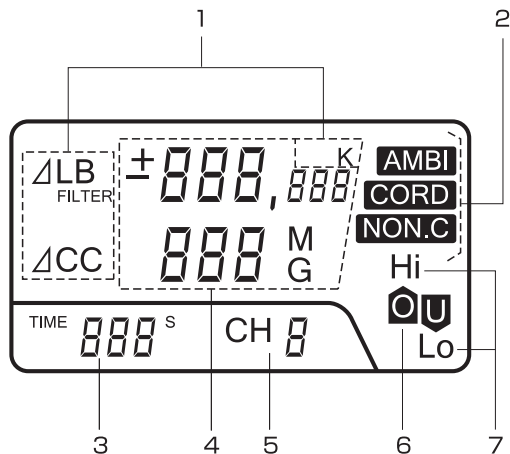

For the purpose of explanation, the diagram above shows all indicators that light up on the LCD.

1. Display-mode indications

2. Measuring-mode indications

Indicate selected measuring mode.

3. "TIME" display (Not displayed in "AMBI" measuring mode)



Indicates shutter speed for flash measurements in fractions of a second (for 1 second, value is followed by "S"); "F" indicates flash analyze function (see p.21).

4. Measured values/stored correction value

5. Memory-channel display (Not displayed if memory channel 0 selected)

Indicates selected memory channel.

6. Over-/Under-range indications

-  indicates measurement is over the measuring or display range.
-  indicates measurement is under the measuring or display range.

7. Flash-range indications (Not displayed in "AMBI" measuring mode)

Indicates selected flash measuring range.

Over-/Under-Range Indications

OVER/UNDER MEASURING RANGE

The meter's measuring range is EV3 to EV16.3 in **AMBI** measuring mode and f/2.8 to f/180(at the meter position)in **CORD** or **NON.C** measuring mode. If the illuminance is over or under this range, **O** or **U** will blink respectively (Display-mode indications will not blink).

Over measuring range

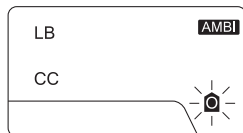

Under measuring range

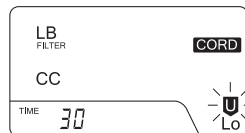

- If **O** blinks: In **AMBI** measuring mode, move away from the light source and take another measurement.
In **CORD** or **NON.C** measuring mode with the flash-range switch set to **Lo**, set the flash-range switch to **Hi** and take another measurement.
If the indication continues to blink, move away from the flash and take another measurement.
- If **U** blinks: In **AMBI** measuring mode, move closer to the light source and take another measurement.
In **CORD** or **NON.C** measuring mode with the flash-range switch set to **Hi**, set the flash-range switch to **Lo** and take another measurement.
If the indication continues to blink, move closer to the flash and take another measurement.

OVER/UNDER DISPLAY RANGE

The meter's display ranges are as follows:

Photographic color temperature: 1,600 to 40,000K

LB index: -500 to +500

CC index: 200G to 200M

LB filter number: 80A+80D to 85B+81EF

Photographic Color Temperature, LB Index, or CC Index

If the calculated values would be over or under the display range or ranges for photographic color temperature, LB index, and/or CC index, the display-mode indications will blink together with either **U** or **Lo**.

LB/CC indexes

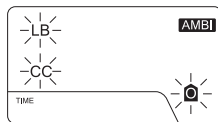

LB filter number/CC index



Photographic color temperature

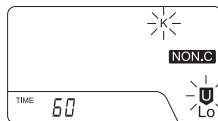

LB Filter Number

If the calculated values would be over or under the display range for LB filter number, the value for LB filter number will be as shown below.

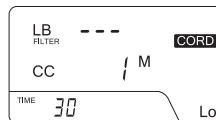

In this case, although the LB filter number cannot be displayed, values for LB index, CC index, and photographic color temperature can be displayed by changing the display mode (see p. 14).

- Measurements outside these display ranges would also be outside the more limited display range for LB filter number.

PREPARATIONS

Power

The Color Meter KCM-3100 is powered by two AA-size 1.5V alkaline-manganese or carbonzinc batteries. Do not use any batteries other than those designated for use with the meter.

INSTALLING BATTERIES

- 1 Remove the battery-chamber cover by pressing on the cover's ridged portion and sliding it in the direction of the arrow.
- 2 Insert the batteries with the polarities as indicated inside the battery chamber.
 - Do not mix battery types or ages.
- 3 Replace the battery-chamber cover.

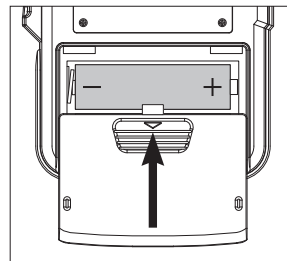
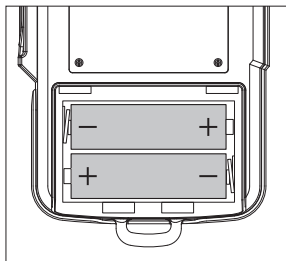
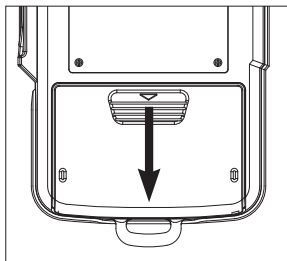

Immediately after the batteries are installed, all of the meter's displays and indications will appear for a few seconds, and then the data panel will change to one of the measurement displays.

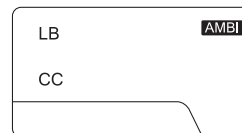
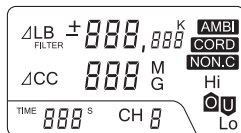

Initial display settings:

Display mode: LB and CC indexes

Measuring mode: According to setting of measuring-mode switch

Memory channel: 0 (no memory channel number displayed)

Flash range*: According to setting of flash-range switch

Shutter speed*: "60" (1/60 second)

*Flash range and shutter speed are not shown in **AMBI** measuring mode.

SWITCHING POWER ON AND OFF

To switch on the meter, press the POWER button; the values for the last measurement will appear in the display. (If the setting of the measuring-mode switch, or of the flash-range switch in CORD or NON.C measuring mode, has been changed since the last measurement, no values will be displayed.) The meter is then ready to take measurements.

To switch off the meter, press the POWER button again.

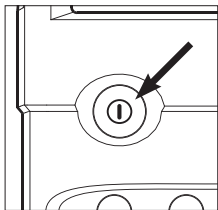

AUTO POWER OFF

To conserve power, the meter automatically switches off if you do not take a measurement or operate any of the switches or buttons for four minutes. To switch the meter back on, press the POWER button. The display shown in the data panel just before the meter was switched off will reappear.

- If the setting of the film-type switch is different from the setting when the meter automatically switched off, the displayed values will be those for the new setting.
- If the setting of the measuring-mode switch, or of the flash-range switch in CORD or NON.C measuring mode, is different from the setting when the meter automatically switched off, no data will be shown in the data panel when the meter is switched back on.

LOW-POWER WARNING

When the power of the batteries becomes low, all displayed values and indications will blink. The meter's batteries should then be replaced with new ones.

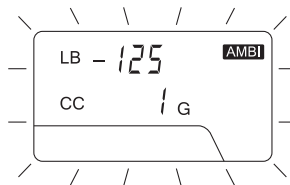

⚠ WARNING Do not throw batteries into fire. Do not recharge, short circuit, heat or disassemble batteries. Otherwise, there is a risk of causing fire or injury due to an explosion or fluid leakage.

⚠ CAUTION Do not use any batteries other than those designated for use with the instrument. When fitting batteries into the instrument, make sure to align them according to the polarity shown on the instrument (plus "+" and minus "-"). Otherwise there is a risk that the batteries may leak or become damaged, leading to fire, injury or pollution of the surrounding environment.

Setting Film-Type Switch

To obtain correct results, the film-type switch must be set to the position corresponding to the film to be used.

B : Type-B tungsten films balanced for 3200K

A : Type-A tungsten films balanced for 3400K

D : Daylight films balanced for 5500K

- If the setting of the film-type switch is changed after a measurement has been taken, the displayed values will be recalculated for the new setting.
- When using digital camera in the sunlight mode, set the film-type switch to D: daylight films (5500K).

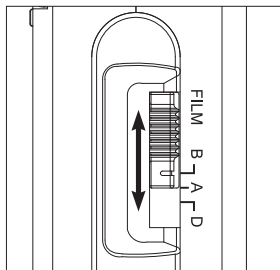

Selecting Display Mode

The meter offers three different display modes: LB index/CC index, LB filter number/CC index, and photographic color temperature.

To select the desired display mode, press the **DISPLAY** button.

The display mode will change in the following order each time the **DISPLAY** button is pressed.

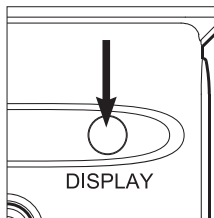

- Displayed values will be recalculated and displayed in the new display mode when the display mode is changed.

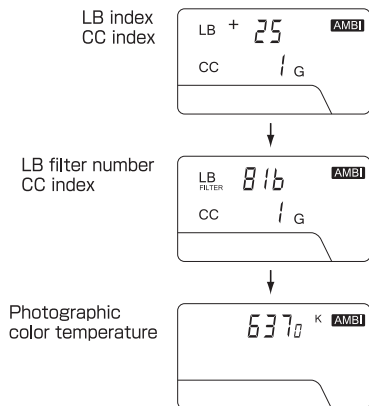

DISPLAY MODES

LB and CC Indexes

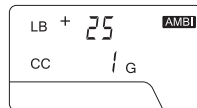

LB index : mired shift value of required light-balancing filter
 CC index : nominal value of required color-compensating filter

LB Filter Number and CC Index

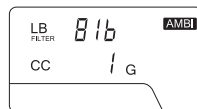

LB filter numbers are equal to LEE Color Temperature Shift Filter numbers or Kodak Wratten filter numbers.
 (If two LB filter numbers are shown, use both filters together)

CC index : nominal value of required color-compensating filter

- For LB filter numbers, "b" indicates B(as in 80B), "d" indicates D(as in 80D), and "E" indicates EF (as in 81EF).

Photographic Color Temperature



Photographic color temperature* in Kelvins

* Photographic color temperature is determined based on the spectral response of color film.

NOTES ON MEASUREMENTS

- When taking a measurement, be careful to avoid the influence of reflectance from objects, such as your body or clothes, which will not affect the light illuminating the subject.
- The receptor head can be rotated 90° to right or 180° to the left.

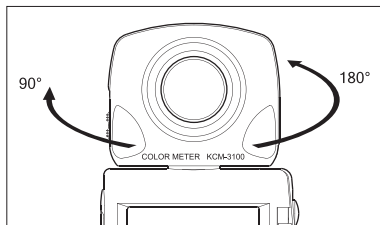

In general, measurements should be taken with the meter facing the light source and positioned close to the light source. This method will provide satisfactory results in many situations.

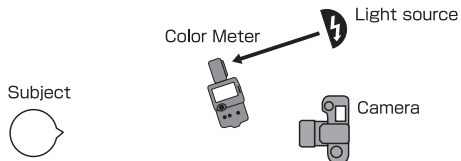

However, in some cases, the light illuminating the subject may not be the same as the light emitted by the light source. This is especially true if the subject is near an object, such as a wall, which will reflect light onto the subject; the light which illuminates the subject after being reflected by the object takes on the color of that object. In such a case, better results may be obtained if the meter is aimed either at the object or at the camera from the subject's position.

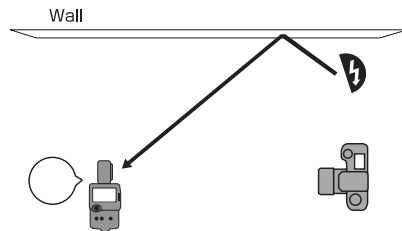

When the subject is illuminated by multiple light sources, correction can be performed in one of the following ways, depending on the particular situation.

- If the light sources will be filtered, measure each light source individually and add the filtration indicated by the meter to the light source.
- If the light sources will not be filtered but are all the same type of light source, either measure each light source individually and determine the approximate average of the meter readings, or take the measurement with the meter facing the camera from the subject position, and use the corresponding filtration over the camera lens.
- If the light sources will not be filtered and are of different types, take the measurement with the meter facing the camera from the subject position and use the corresponding filtration over the camera lens. In this case, color bracketing is also recommended.

The meter will provide accurate filtration recommendations based on the sensitivity corresponding to the setting of the film-type switch in most situations. However, under certain light sources, accurate results may be impossible to obtain. If the results are not exactly what you would prefer, the displayed values can be adjusted to match your preferences using the meter's memory channels; see p.22 for more information.

TAKING MEASUREMENTS

Ambient Light Measurements

To be continued on the next page

- 1 Check that the film-type switch is at the correct position (p.13), the desired display mode is selected (p.14), and the desired memory channel is selected (p.22; if no memory channel number is shown, the selected memory channel is 0).
- 2 Slide the measuring-mode switch up to the "AMBI" position.
 - If the setting of the measuring-mode switch is changed, the previously displayed values will disappear.

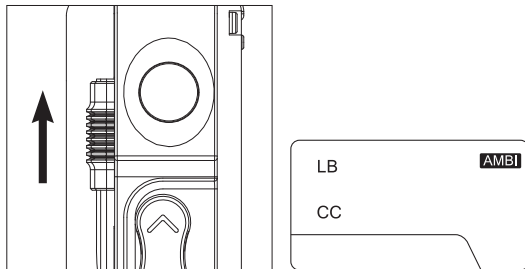

- 3 Aim the meter's receptor toward the light source and press the measuring button to take a measurement. Measurements will be taken continuously while the measuring button is held pressed; the latest measurement results will be held in the display when the measuring button is released.

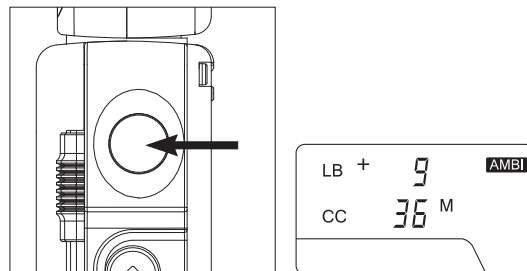

- If the over-range indication () or the under-range indication () blinks in the display, see p.9.

Flash Measurements

WITH AN OVER-THE-COUNTER SYNC CORD

- 1 Check that the film-type switch is at the correct position (p.13), the desired display mode is selected (p.14), and the desired memory channel is selected (p.22; if no memory channel number is shown, the selected memory channel is 0).
- 2 Slide the measuring-mode switch to the "CORD" position.
 - If the setting of the measuring-mode switch is changed, the previously displayed values will disappear.

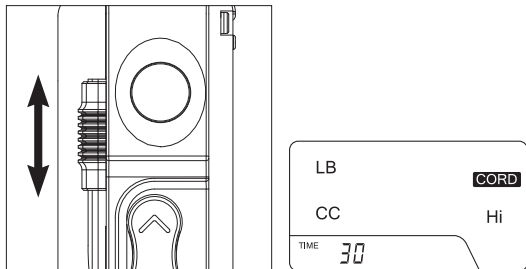

- 3 Set the flash-range switch according to the aperture which would be used at the meter position: For apertures from f/2.8 to f/22, set the switch to Lo; for apertures from f/22 to f/180, set the switch to Hi.

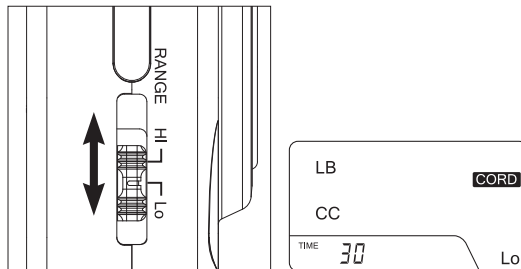

4 Use the up/down control to select the shutter speed to be used.

- Shutter speeds from 1 to 1/500 sec. can be selected in 1-stop increments.
- Be sure that the shutter speed is set within the camera's X-sync range.
- The shutter-speed setting "F", which is the setting above 1/500 sec. sets the meter to analyze mode (see p.21).

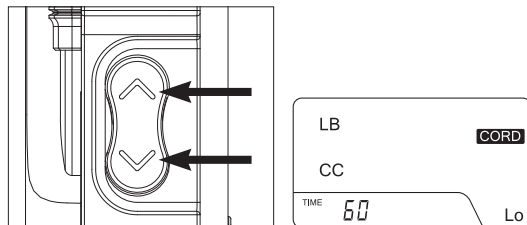
**5** Attach the flash sync cord to the meter's sync terminal.

- Take care when connecting the flash to the instrument with an over-the-counter sync cord, as the flash may fire unexpectedly.

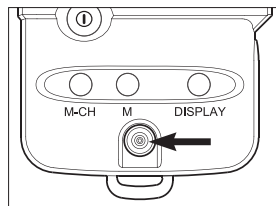
**6** Aim the meter's receptor toward the flash and press the measuring button; the flash will fire and a measurement will be taken.

- The trigger voltage of some electronic flash units may be too low for the meter to fire them in cord mode. If this is true of your flash, use non-cord mode (see p.16).

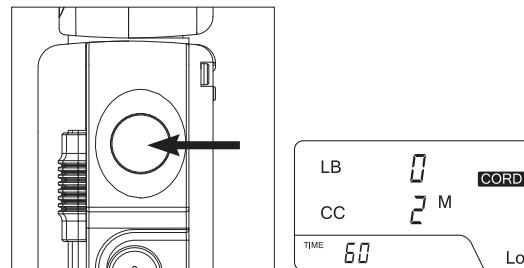

- If the over-range indication (Ⓢ) appears in the display and the flash-range switch is set to **Lo**, set the switch to **Hi**. If the under range indication (Ⓣ) appears and the flash-range switch is set to **Hi**, set the switch to **Lo**. If either indication reappears, see p.9.
- If ambient light is present, the measurement results will be the filtration required for the combination of flash and ambient light. To obtain measurement results for only the light from the flash, see p.21.
- If the shutter speed is changed after measurement, the displayed values will be automatically recalculated for the new shutter speed.

WITHOUT AN OVER-THE-COUNTER SYNC CORD

1 Check that film-type switch is at the correct position (p.13), the desired display mode is selected (p.14), and the desired memory channel is selected (p.22; if no memory channel number is shown, the selected memory channel is 0).

2 Slide the measuring-mode switch to the "NON.C" position.
 · If the setting of the measuring-mode switch is changed, the previously displayed values will disappear.

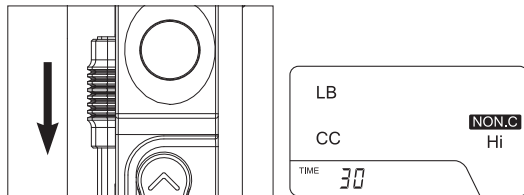

3 Set the flash-range switch according to the aperture which would be used at the meter position: For apertures from f/2.8 to f/22, set the switch to Lo; for apertures from f/22 to f/180, set the switch to Hi.

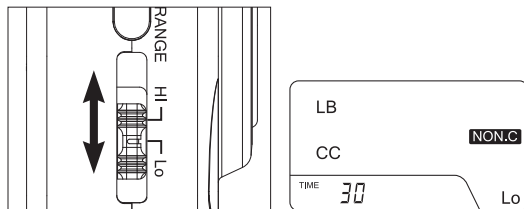

4 Use the up/down control to select the shutter speed to be used.

- Shutter speeds from 1 to 1/500 sec. can be selected in 1-stop increments.
- Be sure that the shutter speed is set within the camera's X-sync range.
- The shutter-speed setting "F", which is the setting above 1/500 sec, sets the meter to analyze mode (see p.21).

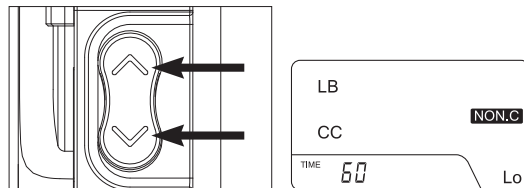

5 Press the measuring button. "NON.C" will start blinking, indicating that the meter is in stand-by mode, waiting for the flash to be fired.

- Stand-by mode will be automatically canceled after 16 seconds if no flash is fired. If the measuring button is pressed while the meter is in stand-by mode, the 16-second period will be restarted.

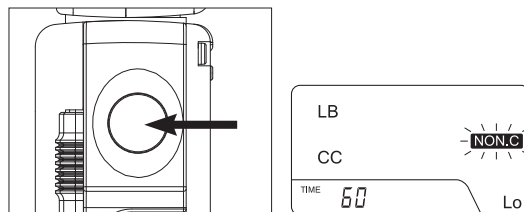

ANALYZE FUNCTION: MEASURING ONLY FLASH IN MIXED LIGHTING

- 6 Aim the meter's receptor toward the flash and fire the flash. The measurement will be taken when the flash is fired and stand-by mode will be canceled ("NON.C" will stop blinking).

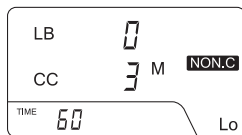

- If the over-range indication (**Lo**) appears in the display and the flash-range switch is set to **Lo**, set the switch to **Hi**. If the under range indication (**Hi**) appears and the flash-range switch is set to **Hi**, set the switch to **Lo**. If either indication reappears, see p.9.
- If ambient light is present, the measurement results will be the filtration required for the combination of flash and ambient light. To obtain measurement results for only the light from the flash, see p.21.
- If the shutter speed is changed after measurement, the displayed values will be automatically recalculated for the new shutter speed.

By using the meter's analyze mode, the photographic color temperature of only the light from the flash or the filtration required for the flash alone can be determined without the influence of the ambient light.

To take measurements in analyze mode, follow the procedure for flash measurements with an over-the-counter sync cord (see p.18) or without an over-the-counter sync cord (see p.20), but set the shutter speed to "F" (the setting above 1/500 sec.). The effective shutter speed when "F" is set is 1/15 sec.

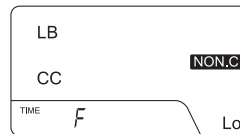

USING MEMORY CHANNELS TO ADJUST METER READINGS

The filtration values determined by the meter are intended to be suitable for as wide a variety of films as possible. However, photographs taken using the unadjusted meter readings may not reproduce scene colors exactly as they are or as you would prefer. The meter has nine memory channels in which you can store values to adjust the meter readings to your preferences. Correction values for LB index and CC index can be input separately, and the stored correction values are used for all film-type settings.

- The meter has ten memory channels in total; however, values in memory channel 0 cannot be changed.
- Correction values in all channels are set to 0 at the time of shipment.

Selecting Memory Channel

- 1** Set the display mode to LB/CC indexes or LB filter number/CC index by pressing the **DISPLAY** button (p.14).
- 2** Press and hold the memory-channel (M-CH) button. "CH" will blink in the display and the presently selected memory channel number will be shown.

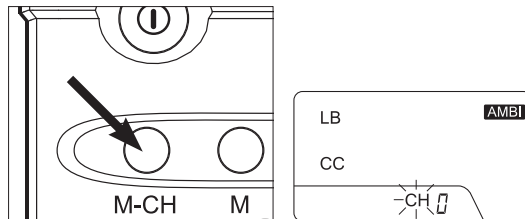

- 3** While continuing to hold the memory-channel button pressed, use the up/down control to select the desired memory channel number.

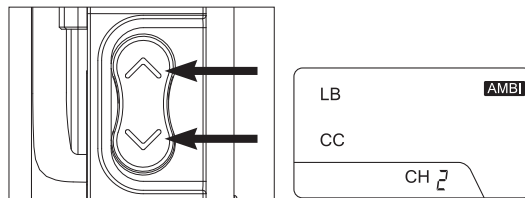

Setting Correction Values

1 Select the memory channel to set correction values in (p.22).

- Correction values cannot be set in memory channel 0.

2 Press and hold the memory (M) button.

Either "ΔLB" or "ΔCC" will blink in the display to indicate which value can be changed.

- To change the value which is not presently blinking, release the memory button, and then press it again.

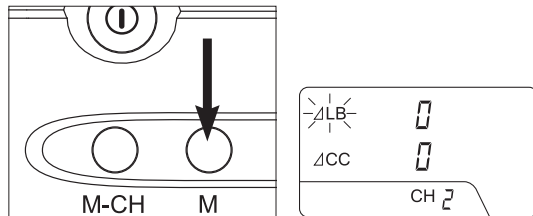

3 While continuing to hold the memory button pressed, use the up/down control to set the correction value.

- Correction values will be added to the initial measurement results to obtain the displayed measurement results.

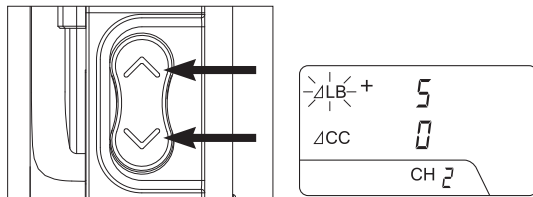

· Correction values can be determined as follows:

- Measure a test scene using the meter set to memory channel 0 (no correction) and note the measurement results.
- Take a series of color-bracketed test photographs, with the measurement results obtained in (a) as the center of the color brackets.
- Evaluate the photographs and select the one with the best color. The filtration used for this photograph will then be used to determine the correction value. (If none of the test photographs have exactly the right color, repeat (b) with the filtration used for the best photograph as the center of the color bracket.)
- Once an acceptable test photograph has been obtained, the LB correction value can be determined by subtracting the LB index measured in (a) from the mired shift value of the filtration used for the test photograph. The CC correction value should be adjusted repeatedly until measurements under the conditions in (a) give values corresponding to the CC filtration used for the test photograph.

SELECTING FILTERS

Select filters based on the meter's readings.

Selecting LB Filters

Display of LB filter numbers

Use LEE Color Temperature Shift filter or Kodak Wratten filter in same number as LB filter number the instrument indicates. If two filter numbers are shown on the display, use both filters together.

- The LB filter number the meter shows corresponds to LB index as below.

LB Index and Corresponding LB Filter Number

LB index	Filter number (LEE, Kodak)
+189<	---
+188 ~ +178	85B + 81EF
+177 ~ +170	85B + 81D
+169 ~ +162	85B + 81C
+161 ~ +154	85B + 81B
+153 ~ +145	85B + 81A
+144 ~ +136	85B + 81
+135 ~ +126	85B
+125 ~ +117	85 + 81
+116 ~ +110	85
+109 ~ +104	85C + 81B
+103 ~ +95	85C + 81A
+94 ~ +86	85C + 81
+85 ~ +76	85C
+75 ~ +66	81EF + 81A
+65 ~ +57	81EF + 81

+56 ~ +47	81EF
+46 ~ +39	81D
+38 ~ +31	81C
+30 ~ +23	81B
+22 ~ +14	81A
+13 ~ +5	81
+4 ~ -5	0
-6 ~ -15	82
-16 ~ -26	82A
-27 ~ -38	82B
-39 ~ -50	82C
-51 ~ -61	80D
-62 ~ -71	80D + 82
-72 ~ -79	80D + 82A
-80 ~ -86	80C
-87 ~ -96	80C + 82
-97 ~ -107	80C + 82A
-108 ~ -117	80B
-118 ~ -126	80B + 82
-127 ~ -136	80A
-137 ~ -146	80A + 82
-147 ~ -157	80A + 82A
-158 ~ -169	80A + 82B
-170 ~ -181	80A + 82C
-182 ~ -192	80A + 80D
-193>	---

Display of LB index

Use LB filter corresponding to LB index* shown below. If you don't have the required filter corresponding to the LB index shown on the display, use filter of the nearest value or use more than one filter together.

- When using two filters together, LB index required is calculated by adding each LB index.
e.g. LB index +20 + LB index +9 = LB index +29
- Do not use more than three filters together.

*LB index indicates the mired (micro reciprocal degree) shift value or the color temperature shift ability value of the required LB filter.

<LB Index and Corresponding LB Filter Number of Other Companies>

Fuji					
Amber line			Blue line		
LB filter number	LB index	Exposure increments(+EV)	LB filter number	LB index	Exposure increments(+EV)
LBA-1	+10	---	LBB-1	-10	---
LBA-2	+20	1/3	LBB-2	-20	1/3
LBA-3	+30	1/3	LBB-3	-30	1/2
LBA-4	+40	1/3	LBB-4	-40	2/3
LBA-8	+80	2/3	LBB-8	-80	1
LBA-12	+120	2/3	LBB-12	-120	1 1/3
LBA-16	+160	1	LBB-16	-160	2
LBA-20	+200	1	LBB-20	-200	2 1/3

Kenko					
Amber line			Blue line		
LB filter number	LB index	Exposure increments(+EV)	LB filter number	LB index	Exposure increments(+EV)
W2	+20	1/4	C2	-20	1/4
W4	+40	2/3	C4	-40	1/2
W10	+100	1	C8	-80	1
W12	+120	1 1/2	C12	-120	1 1/3

Selecting CC Filters

Use CC filter corresponding to CC filter number the meter indicates. If you don't have the required filter corresponding to the CC filter number shown on the display, use filter of the nearest value or use more than one filter together.

- When using two filters together, the CC filter number required is calculated by adding each CC filter number.

e.g.

CC filter number 20M + CC filter number 05M = CC filter number 25M

- * CC filter number 2.5M, 2.5G corresponds to CC025M and CC025G filters of LEE or Kodak respectively. (This meter shows 3M, 3G respectively.) Likewise, 5M, 5G corresponds to CC05M, CC05G respectively.

Exposure Correction When Using Filters.

As the installation of LB or CC filters in the camera reduces the amount of light reaching film surface, exposure should be increased by the degree that the filters lessen the light.

Refer to the conversion table on the back of the meter or on p.27, and obtain the total exposure correction value by adding exposure increments according to the combination of filters to be used.

e.g.

In case of using 82B and CC10M filters of LEE or Kodak, as the exposure increments are +2/3EV and +1/3EV respectively,

$2/3EV + 1/3EV = 1EV$

the total exposure correction value is 1EV.

Open the diaphragm by one f/stop (or slow down the shutter speed by one f/stop in the AMBI mode) when taking photographs.

- Exposure correction is not necessary when using a camera with the built-in exposure device (TTL light measurement).

Exposure Increments Table

LB Filter

Positive(+) LB index: Amber line

LB index	Filter number (LEE, Kodak)	Exposure increments(+EV)
+9	81	$\frac{1}{3}$
+18	81A	$\frac{1}{3}$
+27	81B	$\frac{1}{3}$
+35	81C	$\frac{1}{3}$
+42	81D	$\frac{2}{3}$
+52	81EF	$\frac{2}{3}$
+81	85EF	$\frac{1}{3}$
+112	85	$\frac{2}{3}$
+131	85B	$\frac{2}{3}$

Negative(-)LB index: Blue line

LB index	Filter number (LEE, Kodak)	Exposure increments(+EV)
-10	82	$\frac{1}{3}$
-21	82A	$\frac{1}{3}$
-32	82B	$\frac{2}{3}$
-45	82C	$\frac{2}{3}$
-56	80D	$\frac{1}{3}$
-81	80C	1
-112	80B	$1\frac{2}{3}$
-131	80A	2

CC Filter

CC filter number 2.5M~50M: Magenta line

CC filter number	Exposure
2.5M	---
5M~20M	$\frac{1}{3}$
30M~50M	$\frac{2}{3}$

CC filter number 2.5G~50G: Green line

CC filter number	Exposure
2.5G	---
5G~20G	$\frac{1}{3}$
30G~40G	$\frac{2}{3}$
50G	1

*Exposure increments of filters other than those of LEE or Kodak, see p.25.

CARE AND STORAGE

- Do not press on or damage the data panel.
- Do not subject the meter to shock or vibration.
- This meter should be used at temperatures between -10 and 50°C (14 and 122°F). Operation at temperatures outside this range may be unsatisfactory.
- This meter should never be placed or left in the glove compartment or other places in a motor vehicle, or in other locations where it may be subject to temperatures higher than 55°C (131°F) or lower than -20°C (-4°F), as it may be permanently damaged. Particular care should be taken not to leave the meter in direct sunlight or near sources of heat such as strong lights, etc. Do not store this meter in humid places or near corrosive chemicals.
- If the meter is left or placed in direct sunlight for any long period, the data panel may turn black.
- When the meter is to be stored, place it in its original packing and put it in an airtight container with an appropriate amount of dehumidifying agent, such as silica gel.
- Never attempt to disassemble the meter. Any necessary repairs should be performed only by an authorized Minolta service facility.
- The meter body may be wiped with a silicone-treated cloth to clean it. Do not allow alcohol or chemicals of any other kind to touch its surface.
- Never lubricate any part of the meter.

BATTERY CAUTIONS

- Improper handling of batteries may result in explosion, burn, or heat generation.
- Do not attempt to disassemble, recharge, or short out the battery, or subject it to high temperatures or fire.
 - Never use batteries that show signs of leaking or cracking.
 - When inserting batteries, make sure the + and - terminals face in the correct direction.
 - Don't mix batteries of different types, ages or brands.
 - For extended storage, remove the batteries. Otherwise, leaking or gas generation may occur.
 - Read and follow all warnings and instructions supplied by the battery manufacturer.

SPECIFICATION

Type	Three-color digital color meter for color photograph; determines filtration required and photographic color temperature of light sources
Receptor head	Rotating (90° to right/180° to left) receptor head containing three silicon photocells (filtered to red, green, and blue sensitivities appropriate for color photography)
Film - type settings	D : Daylight film balanced to 5500K A : Type-A Tungsten film balanced to 3400K B : Type-B Tungsten film balanced to 3200K
Measuring modes	Ambient (AMBI) ; flash (CORD, NON.C)
Measuring range (ISO 100)	Ambient : EV3 to 16.3 Flash : f/2.8 to 180 (in two ranges)
Shutter-speed setting range (for flash measurements)	1 to 1/500 sec. in 1-stop increments
Display	Liquid crystal (LCD)
Display modes	LB index and CC index ; LB filter number and CC index ; photographic color temperature
Display range	LB index : -500 to 500 mireds CC index : 200G to 200M LB filter number : 80A+80D to 85B+81EF Photographic color temperature : 1600 to 40,000K
Analyze function	Determines measurement values for only flash light in mixed flash/ambient situations
Memory function	9 memory channels for storing correction values to adjust calculated filtration (LB index and CC index); stored values automatically added to initially calculated values before display of results Correction-value range: Δ LB : -100 to +100 mireds Δ CC : 100G to 100M
Repeatability	LB index : 2 mireds CC index : 2 digits Photographic color temperature : Corresponding to 2 mireds
Power source	2 AA-size batteries
Dimensions	170×70×28mm (6-7/10×2-3/4×1-1/8 in.)
Weight (without batteries)	185g (6.5 oz.)
Standard accessories	Case; strap

■ The meter's case has a memo holder in which you can put these cards.

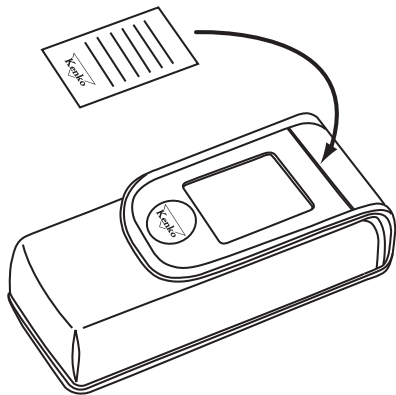

Kenko

Kenko

Kenko
